

DS-1280ZJ-DM18



FEATURES:

- Aluminum alloy material with surface spray treatment
- Waterproof design

HIKVISION

DS-1280ZJ-DM18

SPEC

Parameters	Power intake box
Colour	Hik White
Feature	Suitable for dome cameras
Material	Aluminum Alloy
Dimension	Ø101 x 38mm
Weight	238g

INFORMATION:

- The bracket should be installed on a flat wall
- The wall must be capable of supporting over 3 times as much as the total weight of the camera and the mount
- The maximum load capacity of the bracket is 4.5kg
- Waterproof ribber is necessary for outdoor application

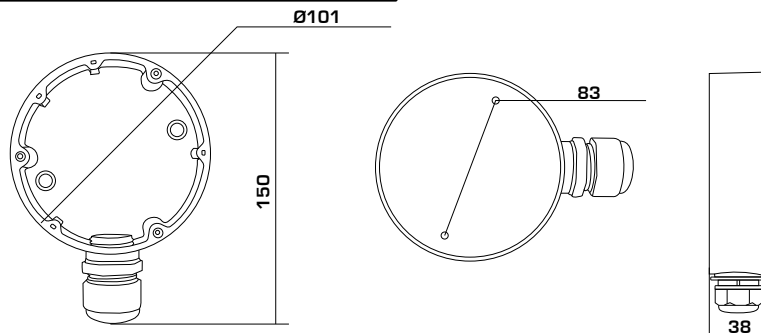

unit: mm

Installation View

1. Choose appropriate wall to install the bracket with and thread the cable

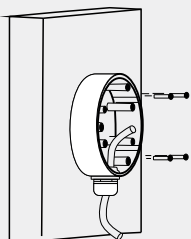

2. Separate basement and dome of camera

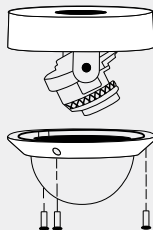

3. Fix the basement of camera to bracket and thread the cable

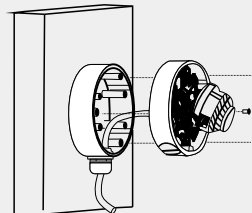

4. Adjust the angle of view, fix the lower case, and complete the installation

